



Operator's Manual

Model 8500

Handheld Pulse Oximeter

R_X Only
CE 0123

English



Follow Instructions for Use.

Nonin® reserves the right to make changes and improvements to this manual and the products it describes at any time, without notice or obligation.



Nonin Medical, Inc.
13700 1st Avenue North
Plymouth, Minnesota 55441, USA

+1 (763) 553-9968
(800) 356-8874 (USA and Canada)
Fax: +1 (763) 553-7807
E-mail: info@nonin.com

Nonin Medical B.V.
Prins Hendriklaan 26
1075 BD Amsterdam, Netherlands

+31 (0)13 - 79 99 040 (Europe)
Fax: +31 (0)13 - 79 99 042
E-mail: infointl@nonin.com

nonin.com

CE 0123



MPS, Medical Product Service GmbH
Borngasse 20
D-35619 Braunfels, Germany

References to “Nonin” in this manual shall imply Nonin Medical, Inc. Nonin, PureLight and nVISION are registered trademarks or trademarks of Nonin Medical, Inc. Microsoft® and Windows® are registered trademarks of Microsoft Corporation.

© 2019 Nonin Medical, Inc.
6130-001-05

Contents

Indications for Use	1
Warnings	1
Cautions	2
Guide to Symbols	4
Displays and Indicators	6
SpO ₂ Display	6
Pulse Rate Display	6
Pulse Quality Indicator.....	6
Low Battery Indicator.....	6
Sensor Fault or Inadequate Signal Display	6
Using the 8500 Pulse Oximeter	8
Unpacking the Model 8500.....	8
Installing and Using the Batteries	8
Important Notes about Battery Use	9
Connecting the Sensor	10
Turn On/Off.....	10
Startup Self-Test.....	11
Detailed Operation	12
Setup Mode	12
Entering Setup Mode	12
Care and Maintenance.....	13
Visual Indicators	14
Communications.....	15
Serial Output.....	15
Connecting the Device into a Medical System	16
Service, Support and Warranty	17
Warranty	18
Parts and Accessories	19
Troubleshooting	20
Technical Information	22
Manufacturer's Declaration.....	22
Essential Performance	22
Equipment Response Time	24
Testing Summary	25
SpO ₂ Accuracy Testing.....	25
Pulse Rate Motion Testing.....	25
Low Perfusion Testing	25
Principles of Operation	25

Contents (Continued)

Specifications	26
----------------------	----

Figures

Figure 1. Front View	7
Figure 2. Installing Batteries in the 8500	9
Figure 3. Connecting a Sensor.....	10

Tables

Table 1. Labeling Symbols.....	4
Table 2. Electromagnetic Immunity.....	22
Table 3. Electromagnetic Immunity.....	23
Table 4. Not Applicable.....	23

Indications for Use

Nonin[®] Model 8500 Handheld Pulse Oximeter is indicated for use in measuring and displaying functional oxygen saturation of arterial hemoglobin (SpO₂) and pulse rate for adult, pediatric, and neonatal patients in hospitals, ambulatory, home and EMS environments. Model 8500 is intended for continuous monitoring and/or spot-checking of patients when attended by a healthcare professional.

Warnings

Do not use in an explosive atmosphere or in the presence of flammable anesthetics or gasses.
Do not use this device in an MR environment.
This device is not defibrillation proof per IEC 60601-1.
This device is intended only as an adjunct in patient assessment. It must be used in conjunction with other methods of assessing clinical signs and symptoms.
Inspect the sensor application site at least every 4 hours to ensure correct sensor alignment and skin integrity. Patient sensitivity to the sensor may vary due to medical status or skin condition.
Oximeter readings of this device may be affected by the use of an electrosurgical unit (ESU).
To avoid patient injury, use only with Nonin-branded PureLight [®] pulse oximeter sensors. These sensors are manufactured to meet the accuracy specifications for Nonin Pulse Oximeters. Using other manufacturers' sensors can result in improper pulse oximeter performance.
To prevent improper performance and/or patient injury, verify compatibility of the monitor, sensor(s), and accessories before use.
No modifications to this device are allowed as it may affect device performance.
Do not use a damaged sensor. If the sensor is damaged in any way, discontinue use immediately and replace the sensor.
As with all medical equipment, carefully route patient cabling to reduce the possibility of entanglement, strangulation, or injury to the patient.
This device should not be used adjacent to or stacked with other equipment. If adjacent or stacked use is necessary, the device should be observed carefully to verify normal operation.
The use of accessories, sensors, and cables other than those specified in the Parts and Accessories List may result in increased electromagnetic emission and/or decreased immunity of this device.
This device must be able to measure the pulse properly to obtain an accurate SpO ₂ measurement. Verify that nothing is hindering the pulse measurement before relying on the SpO ₂ measurement.
Operation of this device below the minimum amplitude of 0.3% modulation may cause inaccurate results.
Discontinue use of adhesive tape strips if the patient exhibits an allergic reaction to the adhesive material.
Avoid excessive pressure to the sensor application site as this may cause damage to the skin beneath the sensor.
The device turns off after approximately 10 minutes when at critically low battery capacity.
Before changing the batteries, make sure the device is off and the sensor is not applied to a digit.
Portable RF communications equipment such as cell phones or radios (including peripherals such as antenna cables and external antennas) should be used no closer than 30 cm (12 inches) to any part of the ME system, including cables specified by the manufacturer. Otherwise, degradation of the performance of this equipment could result.

Cautions

<p>Before use, carefully read the Instructions for Use provided with the sensors.</p>
<p>When mounting the monitor to a mobile pole, mounting the monitor higher than 1.5 meters (5 feet) or mounting more than 2 kilograms (4.5 pounds) of equipment onto the pole may result in tipping, damage to the equipment, or injury.</p>
<p>This device is not an apnea monitor.</p>
<p>Verify that all visible indicators illuminate during the startup (initialization) sequence. If any indicator is not lit, do not use the device. Contact Nonin Technical Service for assistance.</p>
<p>The presence of a defibrillator may interfere with the performance of this device.</p>
<p>This device may not work on all patients. If you are unable to achieve stable readings, discontinue use.</p>
<p>This device has motion tolerant software that minimizes the likelihood of motion artifact being misinterpreted as good pulse quality. In some circumstances, however, the device may still interpret motion as good pulse quality. Minimize patient motion as much as possible.</p>
<p>Ear Clip and Reflectance sensors are not recommended for pediatric or neonatal use. The accuracy of these sensors has not been established for pediatric or neonatal use.</p>
<p>Do not autoclave or immerse the device or sensors in liquid. Do not expose the device or components to excessive moisture or liquids.</p>
<p>Do not use caustic or abrasive cleaning agents on the device or the sensors.</p>
<p>The oximeter sensor might not work on cold extremities due to reduced circulation. Warm or rub the finger to increase circulation, or reposition the sensor.</p>
<p>Always replace the batteries with fully charged batteries. Do not use fully charged and partially charged batteries at the same time as this may cause the batteries to leak.</p>
<p>Use only Nonin-specified battery types with this device.</p>
<p>Do not remove any covers other than the battery cover when replacing batteries. There are no user-serviceable parts inside other than the replaceable batteries.</p>
<p>Follow local, state and national governing ordinances and recycling instructions regarding disposal or recycling of the device and device components, including batteries.</p>
<p>Batteries may leak or explode if used or disposed of improperly.</p>
<p>Remove the batteries if the device will be stored for more than 1 month.</p>
<p>This equipment complies with IEC 60601-1-2 for electromagnetic compatibility for medical electrical equipment and/or systems. This standard is designed to provide reasonable protection against harmful interference in a typical medical installation. However, because of the proliferation of radio-frequency transmitting equipment and other sources of electrical noise in healthcare and other environments, it is possible that high levels of such interference due to close proximity or strength of a source might disrupt the performance of this device. Medical electrical equipment needs special precautions regarding EMC, and all equipment must be installed and put into service according to the EMC information specified.</p>
<p>In compliance with the European Directive on Waste Electrical and Electronic Equipment (WEEE) 2002/96/EC, do not dispose of this product as unsorted municipal waste. This device contains WEEE materials; please contact your distributor regarding take-back or recycling of the device. If you are unsure how to reach your distributor, please call Nonin for your distributor's contact information.</p>

Cautions (Continued)

This device is designed to determine the percentage of arterial oxygen saturation of functional hemoglobin. Factors that may degrade pulse oximeter performance or affect the accuracy of the measurement include the following:

- excessive ambient light
- excessive motion
- electro-surgical interference
- blood flow restrictors (arterial catheters, blood pressure cuffs, infusion lines, etc.)
- moisture in the sensor
- improperly applied sensor
- incorrect sensor type
- inadequate signal
- venous pulsations
- anemia or low hemoglobin concentrations
- cardiogreen and other intravascular dyes
- carboxyhemoglobin
- methemoglobin
- dysfunctional hemoglobin
- artificial nails or fingernail polish.
- residue (e.g., dried blood, dirt, grease, oil) in the light path

When using the monitor in the home, avoid exposing the monitor to lint and dust.

When using the monitor around small children and pets, avoid leaving the monitor unattended. Cables pose a risk of injury, including strangulation.

A functional tester cannot be used to assess the accuracy of a pulse oximeter monitor or sensor.

All parts and accessories connected to the serial port of this device must be certified according to at least IEC Standard EN 60950, IEC 62368-1, or UL1950 for data-processing equipment.

This device is a precision electronic instrument and must be repaired by trained Nonin personnel only. Field repair of the device is not possible. Do not attempt to open the case or repair the electronics. Opening the case may damage the device and void the warranty.

Any sign or evidence of opening the system, field service by non-Nonin personnel, tampering, or any kind of misuse or abuse of the system, shall void the warranty in its entirety.

Failure of a network data coupling (serial cable/connectors) will result in loss of data transfer.

Guide to Symbols

This table describes the symbols that are found on the Model 8500 and in this manual.

Table 1: Labeling Symbols

















Symbol	Description
	CAUTION!
	Follow Instructions for Use.
	Type BF Applied Part (Patient isolation from electrical shock).
	UL Mark for Canada and the United States with respect to electric shock, fire, and mechanical hazards only in accordance with UL 60601-1 and CAN/CSA C22.2 No. 601.1.
CE 0123	CE Marking indicating conformance to EC directive No. 93/42/EEC concerning medical devices.
SN	Serial Number (located on the back cover).
IP33	Protected against spraying water and against access to hazardous parts with a tool, per IEC 60529.
	Indicates separate collection for electrical and electronic equipment (WEEE).
	Authorized Representative in the European Community.
	Manufacturer
	Catalogue number
	Quantity
	Date of manufacture
	Country of manufacture
	Storage/shipping temperature range
	RoHS compliant (China)
Rx Only	Federal law (USA) restricts this device to sale by or on the order of a licensed practitioner.
SpO₂	%SpO ₂ Display

Table 1: Labeling Symbols (Continued)

Symbol	Description
	Pulse Rate Display
	Pulse Quality Indicator
	No Alarms
Front Panel Buttons	
	ON
∅	OFF
	Advance/Dimmer Button

Displays and Indicators

SpO₂ Display

The SpO₂ display is identified by the SpO₂ symbol. This 3-digit light-emitting diode (LED) display shows the current oxygen saturation percentage.

Pulse Rate Display

The Pulse Rate display is identified by the ♥ symbol. This 3-digit LED display shows the pulse rate in pulses per minute.

Pulse Quality Indicator

The Pulse Quality Indicator display (identified by the  symbol) is a tricolor LED that blinks once for each detected pulse. The color of the Pulse Quality indicator changes with the pulse strength signal, as described below.

- **Green** indicates a good pulse strength signal.
- **Amber** indicates a marginal pulse strength signal. To improve signal quality, reposition the sensor, try a different sensor type, reduce patient movement, or improve the site's circulation.
- **Red** indicates an inadequate pulse strength signal. While the Pulse Quality display is red, SpO₂ and pulse rate values are not updated. After about 10 seconds, the values are replaced with dashes, indicating that readings are not possible.

Low Battery Indicator

When battery capacity is low, the display will blink once each second. If the batteries are not replaced, they will reach critically low capacity and the display will blink dashes. The Pulse Quality LED will blink red or amber, not green. After 10 minutes of critically low battery capacity, the display will go blank.

Sensor Fault or Inadequate Signal Display

If the device determines that a sensor fault or inadequate signal condition exists (a sensor disconnect, failure, misalignment or incompatibility with the monitor) or if a pulse oximeter sensor signal is no longer detected, a dash (-) appears in the leftmost position of the SpO₂ display. The readings that are displayed will freeze for 10 seconds if the pulse oximeter sensor fault or the inadequate signal continues.

If the sensor fault or the inadequate signal is not corrected, the frozen readings and the dash in the leftmost position will be replaced by dashes in the middle of both the SpO₂ and the Pulse Rate displays.

When the sensor fault or the inadequate signal is corrected, the SpO₂ and pulse rate displays will return to normal operation.

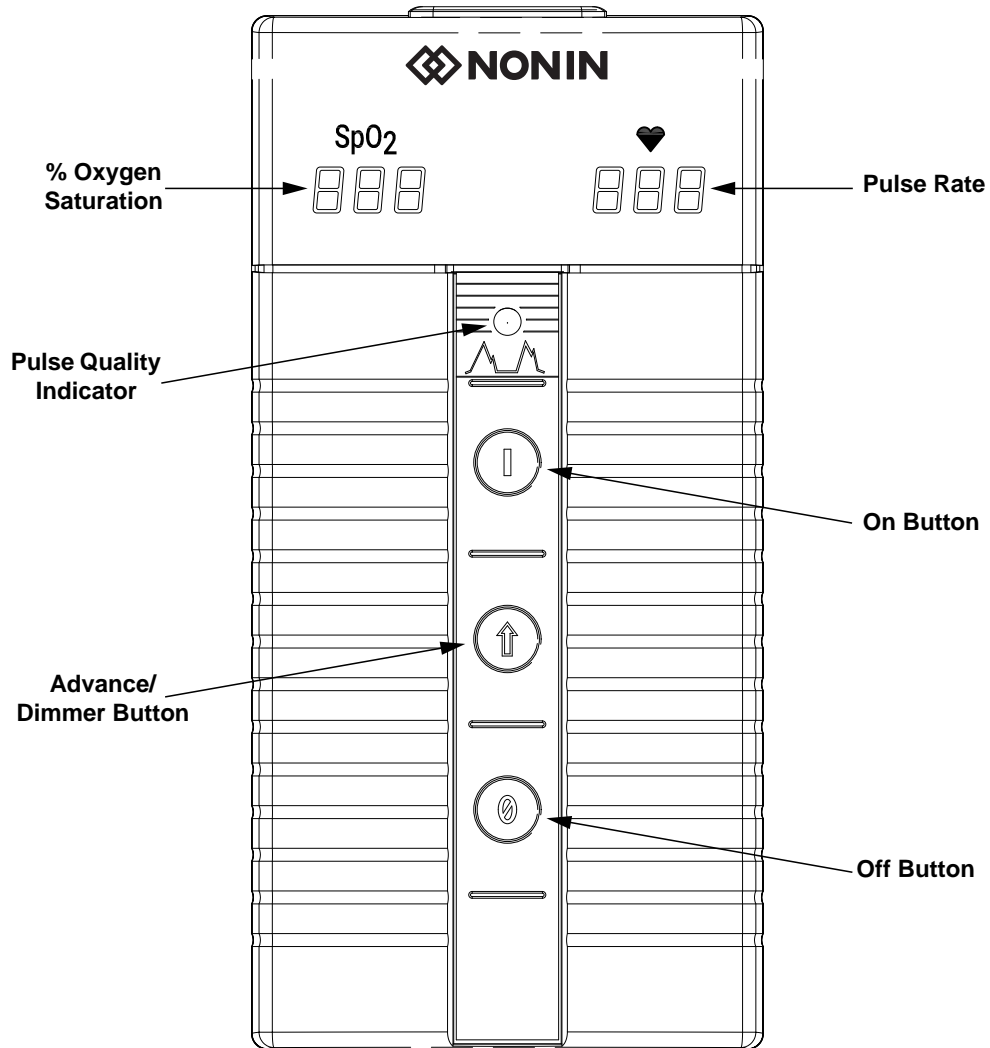

Figure 1: Front View

Using the 8500 Pulse Oximeter

Unpacking the Model 8500

The Model 8500 system includes the following items:

- 1 Model 8500 Pulse Oximeter
- 1 Model 8500 Operator's Manual on CD
- 1 Nonin 8000AA Pulse Oximeter Sensor
- 6 AA-Size Alkaline Batteries

Confirm that the items listed are included with the system. If any item on this list is missing or damaged, contact your distributor. Contact the carrier immediately if the shipping carton is damaged.

Installing and Using the Batteries

The Model 8500 is powered by 6 AA-size alkaline batteries.

WARNING: Before changing the batteries, make sure the device is off and the sensor is not applied to a digit.



CAUTION: Use only Nonin-specified battery types with this device.

1. Press the battery cover latch, and remove the battery cover on the back of the device.
2. Insert six new AA-size alkaline batteries. Insert the batteries as indicated inside the battery compartment. Proper battery positioning is essential for correct operation.
3. Replace the battery cover and turn the device on. If the device does not turn on, see "Troubleshooting."



CAUTION: Always replace the batteries with fully charged batteries. Do not use fully charged and partially charged batteries at the same time as this may cause batteries to leak.

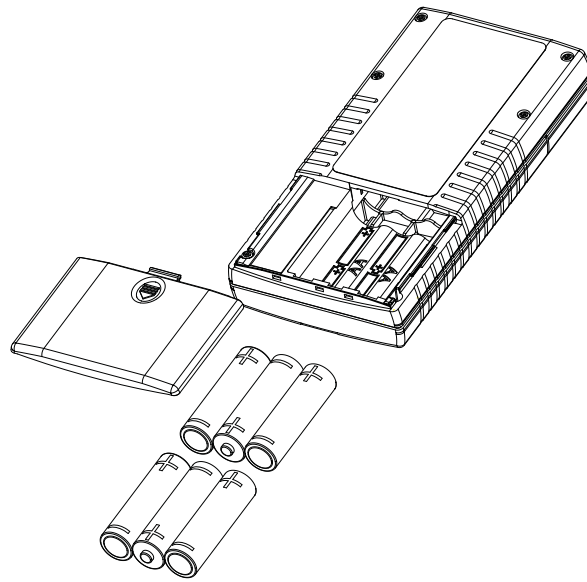

Figure 2: Installing Batteries in the 8500

When batteries are critically low, the digital displays will go blank, and the Pulse Quality display will blink amber or red, but not green. After 10 minutes at critically low battery capacity, the pulse oximeter will shut off automatically.

WARNING: The device turns off after approximately 10 minutes when at critically low battery capacity.



CAUTION: Replace the batteries as soon as possible after a low battery indication. Always replace the batteries with fully charged batteries. Do not use fully charged and partially charged batteries at the same time. This may cause the batteries to leak.



CAUTION: Remove the batteries if the device will be stored for more than 1 month.

Important Notes about Battery Use

- Six AA alkaline batteries provide the device with approximately 100 hours of continuous operation.
- Display brightness can affect battery life; the lower settings will conserve battery life.
- **Clock/calendar settings can affect battery storage life.** Batteries drain during storage, but they drain much more quickly when the unit's clock/calendar functions are set. Refer to "Clock and Calendar Settings" for more information.
 - If the clock/calendar is not set when the unit is stored, alkaline batteries will need replacement in 10-12 months if the unit has not been used.
 - If the clock/calendar is set when the unit is stored and if the unit has not been used, alkaline batteries will require replacement in about 6 weeks.

Connecting the Sensor

Connect the pulse oximeter sensor (with the Nonin logo facing up) to the top of the device as shown. Ensure that the sensor is firmly plugged in. Refer to “Specifications” or to the specific sensor Instructions for Use.

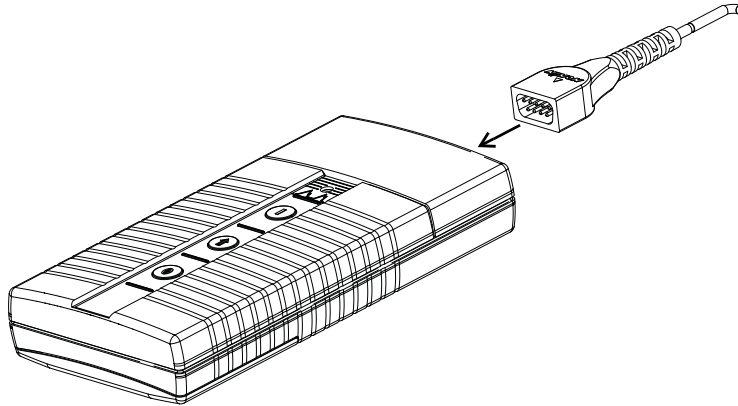

Figure 3: Connecting a Sensor

Turn On/Off

- **Turn on** the device by pressing the ON (|) button.
- **Turn off** the device by pressing the OFF (Ø) button.

To conserve battery life, the device automatically powers off after 10 minutes of inactivity. Inactivity is indicated by dashes on the displays and may result from an improperly connected or positioned sensor, or from an inadequate patient pulse signal.

The Advance/Dimmer button controls the brightness of the digital displays. When turned on, the digital display defaults to the maximum brightness. Pressing the Advance/Dimmer button will decrease the brightness to the lowest setting, and each subsequent press will increase the brightness through 8 different settings. Lower brightness settings will conserve battery life.

NOTE: Reducing the LED display brightness can extend battery life up to 60%.

Startup Self-Test

When the device is turned on, the device will cycle through a startup/initialization sequence before displaying valid data. During startup, always check for any missing indicators or LED display segments. If any indicator is not functioning, do not use the device. Contact Nonin Technical Service for repair or replacement.

During its normal startup sequence, the device will cycle as follows:

- “▯▯▯ ▯▯▯” appears briefly in the SpO₂ and Pulse Rate displays.
- the Pulse Quality display turns red for 1 second, then green for 1 second, then shuts off.
- the clock time currently (in hours and minutes, 04 41 for example) appears briefly in the displays.
- the software revision number (display in the following order): Main revision “r” + 3 numbers: “n” “n” and “no”.
- (-) a dash appears for Model 8500 in the displays until a valid pulse signal is detected.

Apply the pulse oximeter sensor to the patient’s finger; ensure the system is obtaining an adequate pulse signal by verifying:

- the pulse oximeter sensor is properly positioned
- the Pulse Quality indicator is blinking green
- the Pulse Rate and SpO₂ readings are displayed
- the Pulse Quality indicator is blinking in time with the pulse rate for at least 10 seconds

If the Pulse Quality indicator is blinking red or amber or is blinking inconsistently, reposition the sensor or replace the sensor.

The SpO₂ and Pulse Rate will display a single dash until a pulse signal is detected.

Detailed Operation

Setup Mode

Setup mode is used to set the calendar and clock.

In Setup mode, the Advance/Dimmer button and the ON (|) button are used to make all selections.

NOTE: Setting the month to “00” disables the calendar function and conserves battery life.

Entering Setup Mode

1. With the device off, press and hold the Advance/Dimmer button while pressing and then releasing the ON (|) button; the month and year will appear.
2. Release the Advance/Dimmer button when $\overline{\text{---}}$ $\overline{\text{---}}$ appears in the SpO₂ and Pulse Rate displays. The current time and year appear briefly in the displays. To view the other settings, press and release the ON (|) button until all settings are reviewed. To change current settings, press the Advance/Dimmer button until the calendar or clock entry to be changed appears in the display. Dashes appear in the SpO₂ and Pulse Rate displays when Set-Up is complete. The device is ready for use.

To review settings:

- **Press and release** the ON (|) button until all settings are reviewed.

To change settings when set-up mode is entered:

- The year y $\overline{\text{---}}$? (or user-set year) automatically appears in the display;
- **Press** the ON (|) button to advance the calendar/clock options;
- **Set** each calendar or clock option by pressing the Advance/Dimmer button until the correct value is displayed;
- **Press** the ON (|) button to go to the next calendar/clock option;
- **Repeat** until all values are set.

Dashes appear in the SpO₂ and Pulse Rate displays when Set-up is complete. The device is ready for use.

See the table below for display sequence, appearance, and range.

Sequence	SpO ₂ Display	Range
Year	y	00 - 99
Month	nn	00 - 12
Day	d	01 - 31
Hours	h	00 - 23
Minutes	nn	00 - 59

Care and Maintenance

Clean the device separately from the sensors. For instructions on cleaning pulse oximeter sensors, refer to the respective sensor instructions for use.



CAUTION: Do not autoclave or immerse the device or sensors in liquid. Do not expose the device or components to excessive moisture or liquids.



CAUTION: Do not use caustic or abrasive cleaning agents on the device or the sensors.

Clean the device with a soft cloth dampened with isopropyl alcohol or a mild detergent. Do not pour or spray any liquids onto the device, and do not allow any liquid to enter any openings in the device. Allow the device to dry thoroughly before reusing.

The Oxitest^{Plus7} by Datrend Systems, Inc. can be used to verify operation of the pulse oximeter.



Visual Indicators

The intended operator's position for correctly perceiving a visual signal and its priority is 1 meter (3.3 feet).

The following table describes conditions and visual indicators.

Condition	Visual Indication
Pulse Waveform Signal is inadequate	<ul style="list-style-type: none"> Pulse Quality LED blinks red
Sensor Fault (i.e., sensor disconnect, failure, or incompatibility with the monitor)	<ul style="list-style-type: none"> Pulse Quality LED blank Dash (-) appears in the leftmost position of the SpO₂ display SpO₂ and Pulse Rate numeric displays freeze for 10 seconds After 10 seconds a dash (-) replaces the SpO₂ and Pulse Rate numeric displays.
Inadequate Signal (sensor misalignment, ambient light, nail polish/artificial nails, etc.)	<ul style="list-style-type: none"> Pulse Quality LED blinks Dash (-) appears in the leftmost position of the SpO₂ display SpO₂ and Pulse Rate numeric displays freeze for 10 seconds After 10 seconds a dash (-) replaces the SpO₂ and Pulse Rate numeric displays.
Inadequate SpO ₂ or pulse rate data (excessive motion or erratic heart rate, etc.) more than 20 seconds	<ul style="list-style-type: none"> Dash (-) appears in SpO₂ and pulse rate displays
Pulse rate data not updated for more than 30 seconds	<ul style="list-style-type: none"> Pulse rate numeric display becomes dashes
Low Battery	<ul style="list-style-type: none"> SpO₂ and Pulse Rate displays blink.
Critically Low Battery	<ul style="list-style-type: none"> SpO₂ and pulse rate displays are blinking dashes Pulse Quality LED is solid red or amber

Communications

Serial Output

Models 8500 provides real-time data output capability via the pulse oximeter sensor connector (a 9-pin Sub-D connector). The pulse oximeter sensor connector pin assignments are listed below.

Pin Number	Assignment
1	1-Wire [®]
2	Infrared Anode, Red Cathode
3	Infrared Cathode, Red Anode
4	Serial Data, TTL Levels
5	Detector Anode
6	Sensor Type
7	Cable Shield (Ground)
8	No Connection
9	Detector Cathode, +5 V

Information from the device, in the real-time mode, is sent in an ASCII serial format at 9600 baud with 9 data bits, 1 start bit, and 1 stop bit. The data are output at a rate of once per second.

Real-time data may be printed or displayed by devices other than the pulse oximeter. At start up a header is sent identifying the format and the date and time as HH:MM:SS, where “HH” represents the hour, “MM” represents the minutes, and “SS” represents the seconds. The data are sent once per second in the following format:

SPO₂=XXX HR=YYY

where “XXX” represents the SpO₂ value, and “YYY” represents the pulse rate. The SpO₂ and pulse rate will be displayed as “---” if no data is available.

Connecting the Device into a Medical System

Incorporating the device into a medical system requires the integrator to identify, analyze, and evaluate the risks to patient, operators, and third parties. Subsequent changes to the medical system after device integration could introduce new risks and will require additional analysis. Changes to the medical system that must be evaluated include:

- Changing the system configuration
- Adding devices to or disconnecting devices from the system
- Updating or upgrading equipment connected to the system

Issues resulting from user-initiated system changes may include corruption or loss of data.

NOTES:

- When using the serial port to connect the device to other equipment, follow each device's cleaning instructions.
- Verify all equipment connected to the device is suitable for the patient's environment.



CAUTION: Failure of a network data coupling (serial cable/connectors) will result in loss of data transfer.

Service, Support and Warranty



CAUTION: This device is a precision electronic instrument and must be repaired by trained Nonin personnel only. Field repair of the device is not possible. Do not attempt to open the case or repair the electronics. Opening the case may damage the device and void the warranty.



CAUTION: Any sign or evidence of opening the system, field service by non-Nonin personnel, tampering, or any kind of misuse or abuse of the system, shall void the warranty in its entirety.

The advanced digital circuitry within the Model 8500 requires no periodic maintenance or calibration. The device's expected service life is 5 years. Nonin does not recommend field repair of Model 8500. The circuit board in the Model 8500 is a multi-layer board using very narrow traces. Due to the very small trace size, extreme care must be used when replacing components to prevent permanent, non-repairable damage to the circuit board. Most components are surface-mounted and require special hot-air jet soldering and desoldering equipment. After any repairs are made, Model 8500 must be tested to ensure correct operation.

For additional technical information, contact Nonin's Technical Service department at:

Nonin Medical, Inc.

13700 1st Avenue North
Plymouth, Minnesota 55441, USA

(800) 356-8874 (USA and Canada)

+1 (763) 553-9968

Fax: +1 (763) 553-7807

E-mail: technicalservice@nonin.com

Nonin Medical B.V.

Prins Hendriklaan 26
1075 BD Amsterdam, Netherlands

+31 (0)13 - 79 99 040 (Europe)

Fax: +31 (0)13 - 79 99 042

E-mail: technicalserviceintl@nonin.com

nonin.com

All non-warranty work shall be done according to Nonin standard rates and charges in effect at the time of delivery to Nonin. All repairs include a complete retest of the Model 8500 using factory test fixtures.

Warranty

NONIN MEDICAL, INCORPORATED, (Nonin) warrants to the purchaser, for a period of three years from the date of purchase, each Model 8500 Pulse Oximeter exclusive of sensors, cables, and batteries. (Refer to the individual package inserts for specific warranty information for sensors, cables, and other accessories.) Nonin shall repair or replace any Model 8500 found to be defective in accordance with this warranty, free of charge, for which Nonin has been notified by the purchaser by serial number that there is a defect, provided said notification occurs within the applicable warranty period. This warranty shall be the sole and exclusive remedy by the purchaser hereunder for any Model 8500 delivered to the purchaser which is found to be defective in any manner whether such remedies be in contract, tort or by law.

This warranty excludes cost of delivery to and from Nonin. All repaired units shall be received by the purchaser at Nonin's place of business. Nonin reserves the right to charge a fee for a warranty repair request on any device that is found to be within specifications.

The Model 8500 is a precision electronic instrument and must be repaired by knowledgeable and specially trained Nonin personnel only. Accordingly, any sign or evidence of opening the Model 8500, field service by non-Nonin personnel, tampering, or any kind of misuse or abuse of the Model 8500, shall void the warranty in its entirety.

All non-warranty work shall be done according to Nonin standard rates and charges in effect at the time of delivery to Nonin.

DISCLAIMER/EXCLUSIVITY OF WARRANTY:

THE EXPRESS WARRANTIES SET FORTH IN THIS MANUAL ARE EXCLUSIVE AND NO OTHER WARRANTIES OF ANY KIND, WHETHER STATUTORY, WRITTEN, ORAL, OR IMPLIED INCLUDING WARRANTIES OF FITNESS FOR A PARTICULAR PURPOSE OR MERCHANTABILITY SHALL APPLY.

Parts and Accessories

For more information about Nonin parts and accessories:

- See the Parts and Accessories List on the Operator's Manual CD.
- Contact your distributor or Nonin at (800) 356-8874 (USA and Canada), +1 (763) 553 9968, or +31 (0)13 - 79 99 040 (Europe).
- Visit nonin.com.

Detailed information regarding specific sensor use (patient population, body/tissue, and application) can be found in the respective sensor Instructions for Use.

WARNING: The use of accessories, sensors, and cables other than those specified in the Parts and Accessories List may result in increased electromagnetic emission and/or decreased immunity of this device.

WARNING: To avoid patient injury, use only with Nonin-branded PureLight[®] pulse oximeter sensors. These sensors are manufactured to meet the accuracy specifications for Nonin Pulse Oximeters. Using other manufacturers' sensors can result in improper pulse oximeter performance.



Troubleshooting

Problem	Possible Cause	Possible Solution
The device won't turn on.	The batteries are depleted.	Replace all 6 batteries.
	The batteries are installed incorrectly.	Verify battery orientation, illustrated inside the battery compartment or in Figure 2: Installing Batteries in the 8500 section of this operator's manual.
	A metal contact in the battery compartment is missing or damaged.	Contact Nonin Technical Service.
A dash appears in the leftmost position of the SpO₂ display.	A sensor fault exists (disconnect, failure, misalignment, or incompatibility with the monitor).	Verify that the sensor is correctly connected to the device and the patient; replace sensor if the condition persists.
Dashes are displayed in both the SpO₂ and Pulse Rate displays.	No signal is detected because the sensor is not plugged in.	Verify the sensor connections.
	Sensor failure.	Replace the sensor.
Numeric displays are blinking at once per second.	Low batteries.	Replace all 6 batteries.
	Incorrect battery installation.	Verify battery orientation.
The displayed pulse rate does not correlate to the pulse rate displayed on the ECG monitor.	Excessive motion at the sensor site may be prohibiting the device from detecting a consistent pulse signal.	Eliminate or reduce the cause of the motion or reposition the sensor to a new sensor site.
	The patient may have an arrhythmia resulting in some heart beats that do not detect a pulse quality signal at the sensor site.	Assess the patient.
	A non-compatible sensor is being used.	Replace the sensor with a Nonin-branded PureLight sensor.
	The ECG monitor may not be functioning properly.	Assess the patient.
An inconsistent Pulse Rate or an amber Pulse Quality display during the use with electro-surgical unit (ESU).	The ESU may be interfering with the pulse oximeter performance.	Assess the patient. Move the device, cables, and sensors as far away from the ESU as possible.
The Pulse Quality LED is blinking amber with each pulse.	The quality of the pulse signal at the sensor site is inadequate.	Assess the patient. Reposition sensor or select an alternate sensor site.
Numeric display segments are missing.	Defective LEDs.	Discontinue use of the device.
Degradation of device performance.	Electromagnetic interference (EMI).	Remove the device from the EMI environment.

Problem	Possible Cause	Possible Solution
Pulse Quality LED does not blink green.	Inadequate pulse signal or the sensor is not correctly positioned.	Reposition the sensor.
	The sensor is restricting blood circulation at the sensor site.	Remove the restriction to increase blood circulation at the sensor site or relocate the sensor.
	Excessive ambient light.	Reduce ambient light.
	Excessive patient motion.	Reduce patient motion.
	The patient is wearing nail polish or artificial nails.	Remove nail polish or artificial nails.
	Performance degradation from: <ul style="list-style-type: none"> • arterial catheter • blood pressure cuff • infusion line 	Reduce or eliminate the source.
The Pulse Quality display is blinking red and the SpO₂ and/or Pulse Rate displays are dashes.	Inadequate signal at sensor site.	Assess the patient. Reposition sensor or select an alternate sensor site.
	Inadequate pulse signal due to excessive motion.	Reduce patient motion. Reposition or relocate the sensor.
	Sensor failure.	Replace the sensor.

Note: If these solutions do not correct the problem with your device, please contact Nonin Technical Service at (800) 356-8874 (USA and Canada), +1 (763) 553-9968, or +31 (0)13 - 79 99 040 (Europe).

Technical Information

NOTE: This product complies with ISO 10993-1, Biological Evaluation of Medical Devices Part 1: Evaluation and Testing.



CAUTION: A functional tester cannot be used to assess the accuracy of a pulse oximeter monitor or sensor.



CAUTION: All parts and accessories connected to the serial port of this device must be certified according to at least IEC Standard EN 60950, IEC 62368-1, or UL 1950 for data-processing equipment.

WARNING: Portable RF communications equipment such as cell phones or radios (including peripherals such as antenna cables and external antennas) should be used no closer than 30 cm (12 inches) to any part of the ME system, including cables specified by the manufacturer. Otherwise, degradation of the performance of this equipment could result.

Manufacturer's Declaration

Refer to the following tables for specific information regarding this device's compliance to IEC 60601-1-2.

Essential Performance

Essential performance of the 8500 is defined as SpO₂ accuracy and pulse rate accuracy or an indication of abnormal operation. Accuracies may be affected as a result of exposure to electromagnetic disturbances that are outside of the environments listed in the *Indications For Use*. If issues are experienced, move the Nonin system away from the source of electromagnetic disturbances.

Table 2: Electromagnetic Immunity

Emissions Test	Compliance
<i>This device is intended for use in the electromagnetic environment specified below. The user of this device should ensure that it is used in such an environment.</i>	
RF Emissions CISPR 11	Group 1, Class B

Table 3: Electromagnetic Immunity

Immunity Test	Compliance	
Electrostatic Discharge (ESD) IEC 61000-4-2	±8 kV contact ±15 kV air	
Power Frequency (50/60 Hz) Magnetic Field IEC 61000-4-8	30 A/m	
Radiated RF IEC 61000-4-3	80 MHz – 2.7 GHz	10 V/m
	380 – 390 MHz	27 V/m
	430 – 470 MHz	28 V/m
	704 – 787 MHz	9 V/m
	800 – 960 MHz	28 V/m
	1.7 – 1.99 GHz	28 V/m
	2.4 – 2.57 GHz	28 V/m
	5.1 – 5.8 GHz	9 V/m

Table 4: Not Applicable

<p><i>Harmonic Emissions (IEC 61000-3-2), Voltage Flicker Emissions (IEC 61000-3-3), Electrical Fast Transients (IEC 61000-4-4), Surge (IEC 61000-4-5), Voltage dips (IEC 61000-4-11), Conducted Immunity (IEC 61000-4-6).</i></p>
<p>NOTE: These guidelines may not apply in all situations. Electromagnetic propagation is affected by absorption and reflection from structures, objects, and people.</p>

Equipment Response Time

If the signal from the sensor is inadequate, the last measured SpO₂ and pulse rate values freeze for 10 seconds and are then replaced with dashes.

SpO ₂ Values	Average	Latency
Standard/Fast Averaged SpO ₂	4 beat exponential	2 beats

Pulse Rate Values	Response	Latency
Standard/Fast Averaged Pulse Rate	4 beat exponential	2 beats

Equipment Delays	Delay
Display Update Delay	1.5 seconds

Example - SpO₂ Exponential Averaging

SpO₂ decreases 0.75% per second (7.5% over 10 seconds)

Pulse Rate = 75 BPM

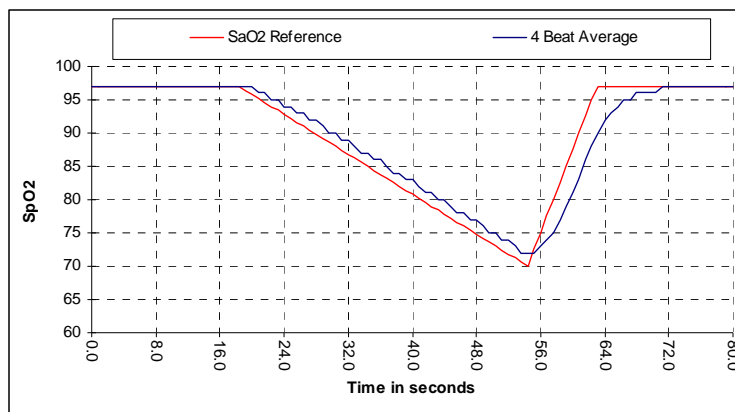

Specific to this example:

- The response of the 4-beat average is 1.5 seconds.

Testing Summary

SpO₂ accuracy, and low perfusion testing was conducted by Nonin Medical, Inc., as described below:

SpO₂ Accuracy Testing

During motion and no-motion conditions at an independent research laboratory, SpO₂ accuracy testing is conducted during induced hypoxia studies on healthy, male and female, non-smoking, light- to dark-skinned subjects that are 18 years of age and older. The measured arterial hemoglobin saturation value (SpO₂) of the sensors is compared to arterial hemoglobin oxygen (SaO₂) value, determined from blood samples with a laboratory co-oximeter. The accuracy of the sensors in comparison to the co-oximeter samples measured over the SpO₂ range of 70 - 100%. Accuracy data is calculated using the root-mean-squared (Arms value) for all subjects, per ISO 80601-2-61, Medical Electrical Equipment—Particular requirements for the basic safety and essential performance of pulse oximeter equipment for medical use.

Pulse Rate Motion Testing

This test measures pulse rate oximeter accuracy with motion artifact simulation introduced by a pulse oximeter tester. This test determines whether the oximeter meets the criteria of ISO 80601-2-61 for pulse rate during simulated movement, tremor, and spike motions.

Low Perfusion Testing

This test uses an SpO₂ Simulator to provide a simulated pulse rate, with adjustable amplitude settings at various SpO₂ levels for the oximeter to read. The oximeter must maintain accuracy in accordance with ISO 80601-2-61 for heart rate and SpO₂ at the lowest obtainable pulse amplitude (0.3% modulation).

Principles of Operation

Pulse oximetry is a non-invasive method that passes red and infrared light through perfused tissue and detects the fluctuating signals caused by arterial pulses. Well-oxygenated blood is bright red, while poorly oxygenated blood is dark red. The pulse oximeter determines functional oxygen saturation of arterial hemoglobin (SpO₂) from this color difference by measuring the ratio of absorbed red and infrared light as volume fluctuates with each pulse.

Specifications

Oxygen Saturation Display Range	0 to 100% SpO ₂
Pulse Rate Display Range	18 to 321 beats per minute (BPM)
Accuracy - Sensors	Declared accuracy data for compatible sensors can be found in Nonin's Sensor Accuracy document.
Measurement Wavelengths and Output Power*	<p>Red: 660 nanometers @ 0.8 mW max. avg.</p> <p>Infrared: 910 nanometers @ 1.2 mW max. avg.</p>
Indicators	<p>Pulse Quality Indicator: LED, tricolor</p> <p>Numeric Displays: 3-digit 7-segment LEDs, red</p>
Temperature	<p>Operating: -20 to +40 °C (-4 to +104 °F)</p> <p>Storage/Transportation: -40 to +70 °C (-40 to +158 °F)</p> <p>Time (from storage) for monitor to be ready: 5 minutes to warm from -40 °C to -20 °C for its intended use: 5 minutes to cool from 70°C to 40 °C</p>
Humidity	<p>Operating: 10 to 90% noncondensing</p> <p>Storage/Transportation: 10 to 95% noncondensing</p>
Altitude	<p>Operating: Up to 4,000 meters (13,123 feet)</p> <p>Hyperbaric Pressure: Up to 4 atmospheres</p>
Power Requirements	Six 1.5V AA-size alkaline batteries. 100 hours maximum display brightness; 160 hours with normal display brightness.
Dimensions	8 cm W x 15 cm H x 2.5 cm D (3 in W x 6 in H x 1 in D)
Weight	280 g (10 oz) (with alkaline batteries)
Classifications per IEC 60601-1 / CAN/CSA-C22.2 No. 601.1 / UL60601-1	<p>Type of Protection: Internally powered (on battery power)</p> <p>Degree of Protection: Type BF-Applied Part</p> <p>Mode of Operation: Continuous</p>
Enclosure Degree of Ingress Protection	IP33

* This information is especially useful for clinicians performing photodynamic therapy.

This device is not made with natural rubber latex.